

1T8613ELTR | CTEVO ARCHITECTURAL 160

Adjustable recessed LED projector in a trimless version

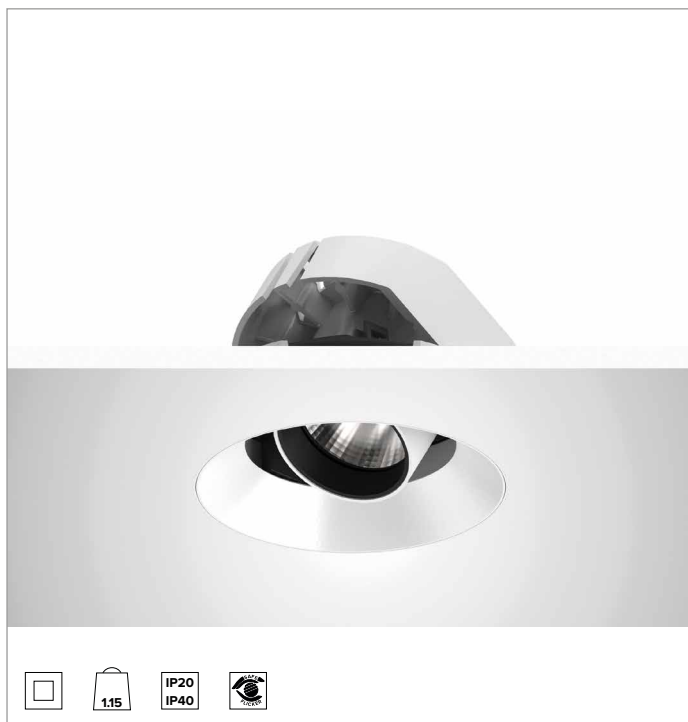

		3500K	H(m)	D(m)	E _{max} (lx)
		Ra90		55°	
Fixture Power	34W	1	1.04	4138	
Source Flux	4347lm	2	2.08	1035	
Fixture Flux	3278lm	3	3.13	460	
Efficacy	96lm/W	4	4.17	259	
TS1279	I _{max} =975cd/klm	I _{max}	4237cd	5	5.21
					166

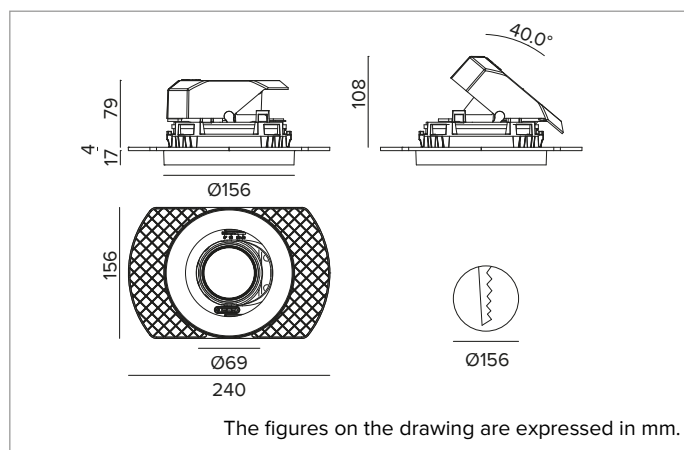

SOURCE

High efficiency Chip on Board LED Ra90. Ra80 on request.

Energy efficiency class: E

Nominal power: 31W

Nominal flux: 4347lm

Colour rendering index: 90

Rf: 91

Rg: 100

CCT nominal: 3500K

Lifetime (L80/B10): >50000h tq +25°C

ILLUMINOTECHNICAL CHARACTERISTICS

WFL - precision optics with a black silicone cut off ring. Version with a convex faceted highly reflective anodised aluminium reflector and a holographic diffusion filter. UGR<22 (EN 12464-1).

Optic: REFLECTOR

Beam angles: WFL

Optical efficiency: 75%

Fixture flux: 3278lm

Luminous efficacy: 96lm/W

Photobiological safety: Compliant with RG1 low risk group

MECHANICAL CHARACTERISTICS

Die-cast white painted anodised aluminium body and dissipator. White colour cover. The optical unit can be adjusted up to 40° on the vertical plane with a mechanical beam locking system and a graduated scale, and 358° on the horizontal plane. Trimless version with a load-bearing element for installation and finishing in plasterboard.

Colour and finish: Plaster white

Weight: 1.15Kg

Version: TRIMLESS

Degree of protection: IP20 for recessed part

Degree of protection: IP40 for exposed part

ELECTRICAL CHARACTERISTICS

Integrated electronic ON-OFF driver.

Fixture Power: 34W

Power supply: 220-240Vac 50/60Hz

Insulation Class: CLASS 2

Type of driver / Control: ON-OFF

Driver included: YES

Class F: YES

SAFE FLICKER: PstLM=<1 and SVM=<0.4 (IEC TR 61547-1 and IEC TR 63158), to ensure a more comfortable and safe light

Ambient temperature: 0°C / +25°C

INSTALLATION

Quick tool-free mounting system for false ceiling installation from 0.5 to 30mm.

NOTES

110-277Vac version available on request.

WARRANTY

5 years.

WARNING

Luminaire designed for disposal/recycling at end-of-life. Replaceable (LED only) light source by a professional. Replaceable control gear by a professional.

Due to the technological evolution of the electronic components, the data provided may be updated, and as such, confirmation must be requested during the order process.

Luminous flux and power supply have +/-10% tolerances with respect to the indicated value. tq +25°C (CIE 121).

We reserve the right to make technical changes.

Targetti Sankey S.r.l.
Via Pratese, 164
50145 Firenze - Italy
Tel: +39 055 37911
targetti.com
targetti@targetti.com

CCIAA Firenze
Share Capital:
€ 500.000,00
VAT N. (IT):
01537660480
R.E.A: FI-275656

TARGETTI

1T8613ELTR | CCTEVO ARCHITECTURAL 160
Adjustable recessed LED projector in a trimless version

Accessories

Filter



Ø mm	Code
63	1T8094

Holographic PMMA filter with blade of light effect.
Allows the beam to be made oval; combined with spot and flood optics the effect appears more pronounced.
Cannot be used with HO versions.

Grid



Ø mm	Code
63	1T8093

Anti-glare louver.
Black painted metal honeycomb structure.
Cannot be used with HO versions.

Mounting System



L mm	Code
2500	1T9606

Anti-fall safety cable to secure the body of the appliance to the building structure.

Due to the technological evolution of the electronic components, the data provided may be updated, and as such, confirmation must be requested during the order process.
Luminous flux and power supply have +/-10% tolerances with respect to the indicated value. tq +25°C (CIE 121).

We reserve the right to make technical changes.

Targetti Sankey S.r.l.
Via Pratese, 164
50145 Firenze - Italy
Tel: +39 055 37911
targetti.com
targetti@targetti.com

CCIAA Firenze
Share Capital:
€ 500.000,00
VAT N. (IT):
01537660480
R.E.A: FI-275656

